

Features

- 80Watts peak pulse power ($t_p = 8/20\mu s$)
- Tiny DFN0603 package
- Bidirectional configurations
- Solid-state silicon-avalanche technology
- Low clamping voltage
- Low leakage current
- IEC 61000-4-2 $\pm 30kV$ contact $\pm 30kV$ air
- IEC 61000-4-4 (EFT) 40A (5/50ns)
- IEC 61000-4-5 (Lightning) 8A (8/20 μs)

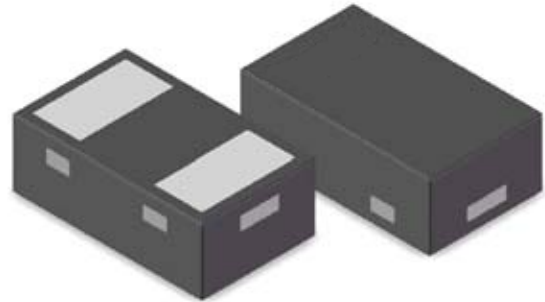

Applications

- Cell Phone Handsets and Accessories
- Microprocessor based equipment
- Personal Digital Assistants (PDA's)
- Notebooks, Desktops, and Servers
- Portable Instrumentation

Mechanical Data

- DFN0603 package
- Molding compound flammability rating: UL 94V-0
- Packaging: Tape and Reel
- RoHS/WEEE Compliant

Schematic & PIN Configuration

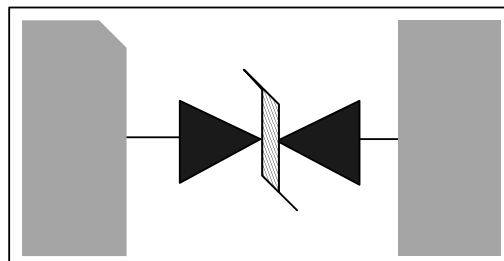

DFN0603



Absolute Maximum Rating

Rating	Symbol	Value	Units
Peak Pulse Power ($t_p = 8/20\mu s$)	P_{PP}	80	Watts
Peak Pulse Current ($t_p = 8/20\mu s$) (note1)	I_{PP}	8	A
ESD per IEC 61000-4-2 (Air) ESD per IEC 61000-4-2 (Contact)	V_{ESD}	30 30	kV
Lead Soldering Temperature	T_L	260(10seconds)	$^{\circ}C$
Junction Temperature	T_j	-55 to + 125	$^{\circ}C$
Storage Temperature	T_{stg}	-55 to + 125	$^{\circ}C$

Electrical Characteristics

Parameter	Symbol	Conditions	Min	Typical	Max	Units
Reverse Stand-Off Voltage	V_{RWM}				5.0	V
Reverse Breakdown Voltage	V_{BR}	$I_T = 1mA$	6.5			V
Reverse Leakage Current	I_R	$V_{RWM} = 5V, T = 25^{\circ}C$		0.1	0.5	μA
Peak Pulse Current	I_{PP}	$t_p = 8/20\mu s$		8		A
Clamping Voltage	V_C	$I_{PP} = 8A, t_p = 8/20\mu s$		10		V
Junction Capacitance	C_j	$V_R = 0V, f = 1MHz$		17		pF

Electrical Parameters (TA = 25 °C unless otherwise noted)

Symbol	Parameter
I_{PP}	Maximum Reverse Peak Pulse Current
V_C	Clamping Voltage @ I_{PP}
V_{RWM}	Working Peak Reverse Voltage
I_R	Maximum Reverse Leakage Current @ V_{RWM}
V_{BR}	Breakdown Voltage @ I_T
I_T	Test Current

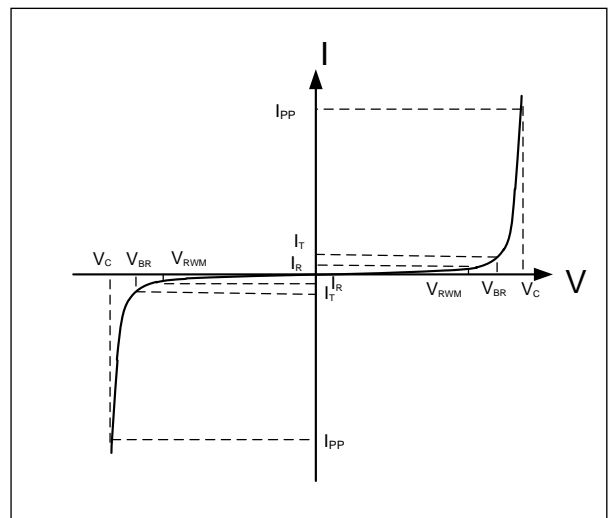

Note: 8/20 μs pulse waveform.



Typical Characteristics

Figure 1: Peak Pulse Power vs. Pulse Time

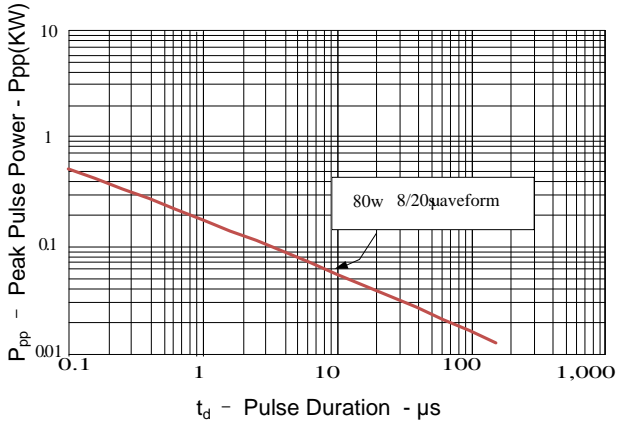

Figure 2: Power Derating Curve

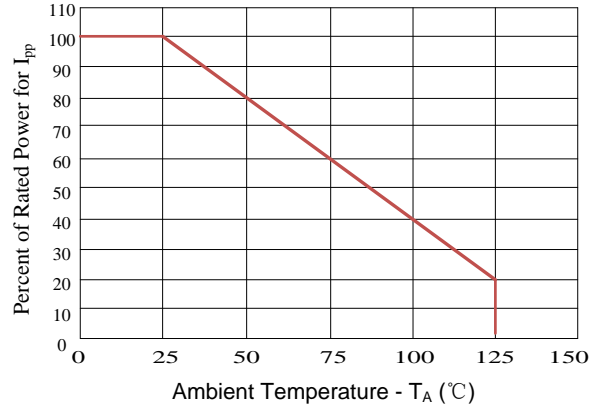

Figure3: Pulse Waveform

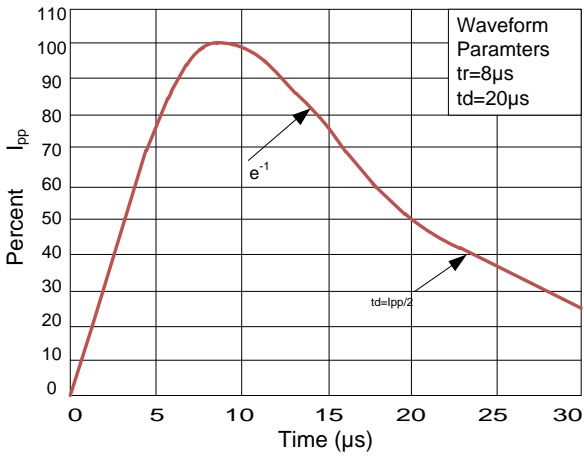
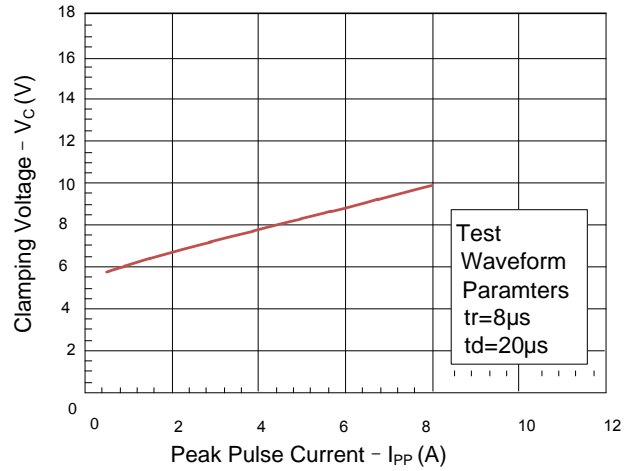
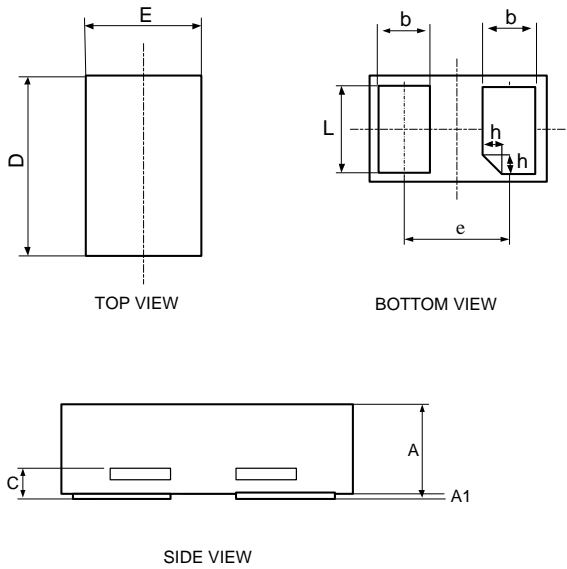

Figure 4: Clamping Voltage vs. Ipp





Outline Drawing – DFN0603



Symbol	Dimensions in millimeters		
	Min	Nom	Max
A	0.28	0.30	0.32
A1	0.00	0.02	0.05
C	0.05	0.10	0.15
D	0.55	0.60	0.65
E	0.25	0.30	0.35
e	0.34	0.35	0.37
b	0.14	0.19	0.24
L	0.20	0.25	0.30
h	0	0.05	0.10

Marking



Ordering information

Order code	Package	Base qty	Delivery mode
RHTVSDF0521N-T	DFN0603	10k	Tape and reel